

# Multi RS Solar 48/6000

With 450 V/4000 W PV input

[www.victronenergy.com](http://www.victronenergy.com)

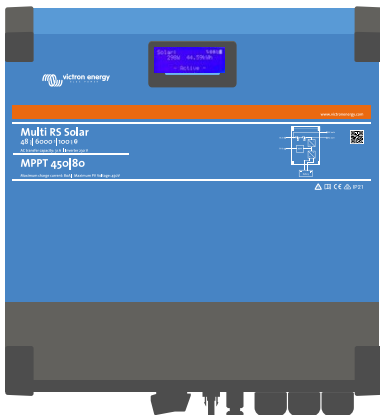

**Multi RS Solar 48/6000**

### Hybrid Inverter/Charger

The Multi RS Solar 48/6000 is a 48 V 6 kVA Inverter/Charger with 450 VDC 4 kWp PV input.

### Combination of an inverter, AC charger, and Solar MPPT

The inverter produces a perfect sine wave, and able to supply high powered appliances. It is also bi-directional, charging the battery when excess solar power or AC supply is available, or converting from the battery when it is needed.

### Wide MPPT voltage range

80 – 450 VDC, with a 120 VDC PV startup voltage.

### Light weight, efficient and quiet

Thanks to high frequency technology and a new design this powerful inverter weighs only 11 kg. In addition to this it has an excellent efficiency, low standby power, and a very quiet operation.

### Display, Bluetooth and VictronConnect app

The display reads battery, inverter and solar parameters. The same parameters can be accessed with a smartphone or other Bluetooth enabled device, using the VictronConnect app.

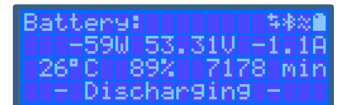

### Extendable PV capacity, both AC-coupled and DC-coupled

The integrated 4 kWp PV capacity can be extended by adding Solar Chargers to the system, for example our Smart Solar Charger range, including the Smart Solar RS models. When connected in a VE.Can network, all battery charging will operate synchronously and coordinated.

Alternatively, the PV capacity can be extended by installing PV Inverters, of which the output power will be automatically controlled by the integrated Frequency Shift Power Control.

### Communication ports

VE.Can connection to a GX device for system monitoring, data logging, and remote firmware updates. VE.Direct connection to a GlobalLink 520 for remote data monitoring.

### I/O Connections

Programmable Relay, temperature sensor and voltage sensor connections. The remote input can also be configured to accept the Victron smallBMS.

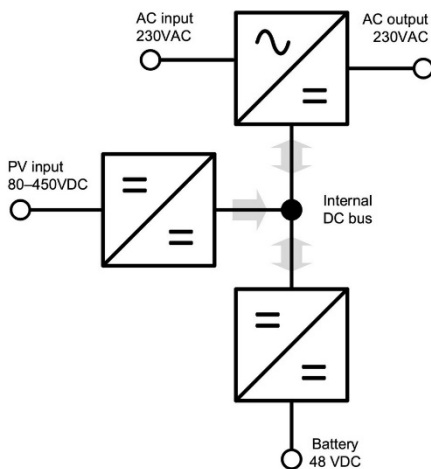

**Inside the Multi RS 48 V 6000 VA**

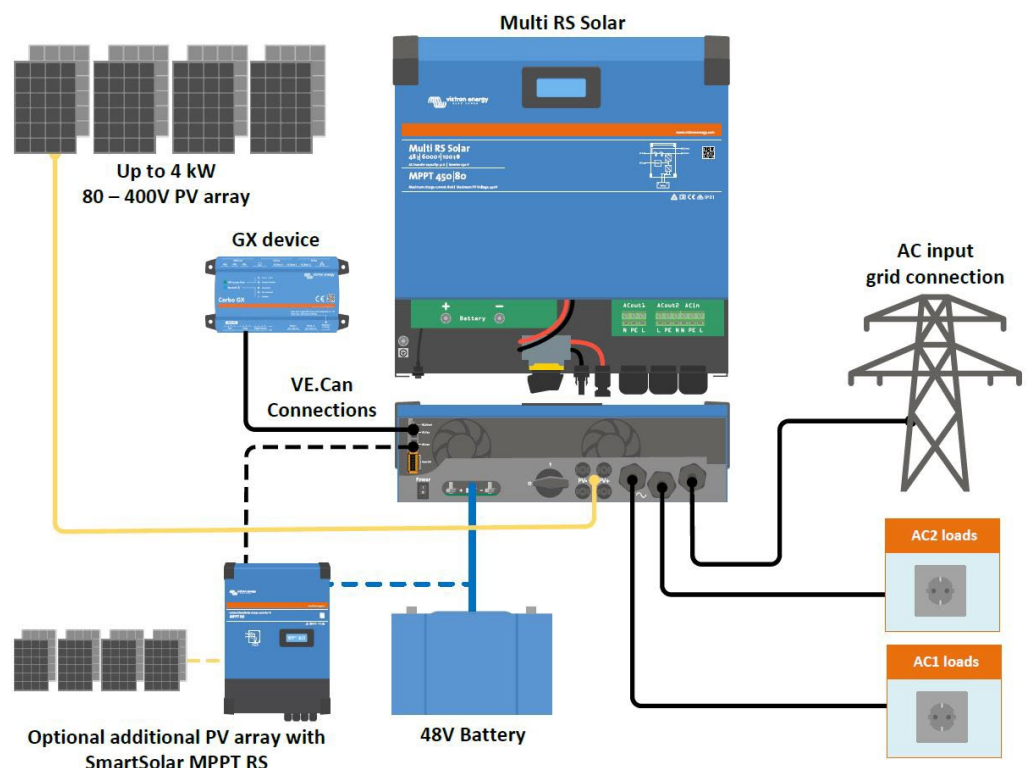

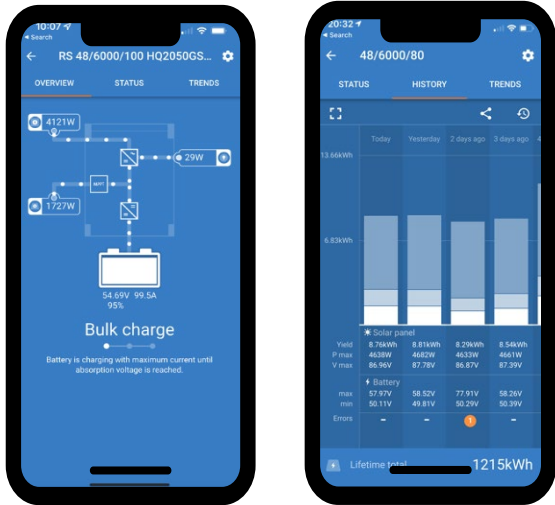

**Configure and monitor with VictronConnect**  
A built in Bluetooth Smart connection allows for quick monitoring or settings adjustment of the Multi RS.

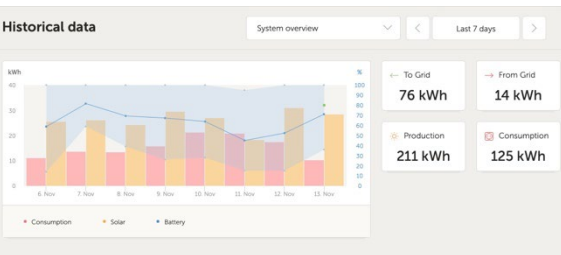
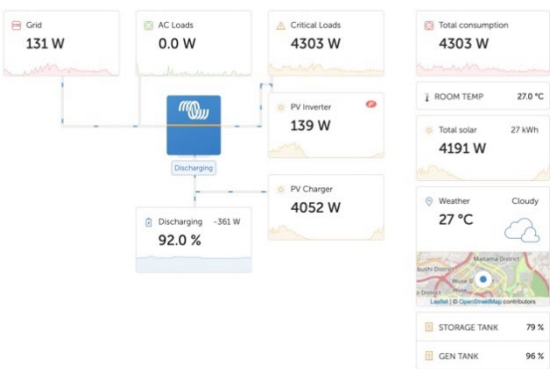

### VRM Portal

When the Multi RS is connected to a GX device with internet connection, you can access our free remote monitoring website (VRM). This will display all your system data in a comprehensive graphical format. System settings can be changed remotely via the portal. Alarms can be received by e-mail.

Multi RS Solar		48/6000
<b>INVERTER</b>		
DC Input voltage range	38 – 62 V (1)	
Output	Output voltage: 230 VAC ± 2 % Frequency: 50 Hz ± 0,1 % (2)	
Continuous output power at 25 °C	Increases linearly from 4800 W at 46 VDC to 5300 W at 52 VDC	
Continuous output power at 40 °C	4500 W	
Continuous output power at 65 °C	3000 W	
Peak power	9 kW for 3 seconds	
Short-circuit output current	50 A	
Max. inverter output AC overcurrent protection	30 A	
Maximum efficiency	96,5 % at 1 kW load 94 % at 5 kW load	
Zero load power	20 W	
Low Battery shutdown	37.2 V (adjustable)	
Low battery restart	43.6 V (adjustable)	
<b>SOLAR</b>		
Maximum DC voltage	450 V	
Start-up voltage	120 V	
MPPT operating voltage range	80 – 450 V (3)	
Max operational PV input current	18 A	
Max PV Short circuit current reverse polarity protection	20 A	
Maximum DC charging power	4000 W	
Max PV short circuit current (Isc PV)	30 A	
Earth leakage trip level	30 mA	
Isolation fail level (detection before start-up)	100 kΩ	
<b>CHARGER</b>		
Programmable Charger voltage range (VDC)	36 – 60 V (7)	
Charge voltage 'absorption' (V DC)	Default setting: 57,6 V (adjustable)	
Charge voltage 'float' (VDC)	Default setting: 55,2 V (adjustable)	
Maximum charge current	100 A	
AC input current limit	31 A	
Battery temperature sensor	Yes	
Battery voltage sense	Yes	
<b>GENERAL</b>		
Parallel and 3-phase operation	no	
Programmable relay (4)	Yes	
Protection (5)	a - g	
Data Communications Ports	VE.Direct port and VE.Can port (6)	
Bluetooth frequency	2402 – 2480 MHz	
Bluetooth power	4 dBm	
General purpose analogue/digital in port	Yes, 2x	
Remote on-off	Yes	
Operating temperature range	-40 to +65 °C (fan assisted cooling)	
Humidity (non-condensing)	max 95 %	
<b>ENCLOSURE</b>		
Material & Colour	steel, blue RAL 5012	
Protection category	IP21	
Battery-connection	M8 bolts	
230 VAC-connection	Screw terminals 13 mm <sup>2</sup> (6 AWG)	
Weight	11 kg	
Dimensions (hxxwxd)	425 x 440 x 125 mm	
<b>STANDARDS</b>		
Safety	EN-IEC 60335-1, EN-IEC 60335-2-29, EN-IEC 62109-1, EN-IEC 62109-2	
Emission, Immunity	EN 55014-1, EN 55014-2 EN-IEC 61000-3-2, EN-IEC 61000-3-3 IEC 61000-6-1, IEC 61000-6-2, IEC 61000-6-3	
1) Minimum start-up voltage is 41 V. Inverter shutdown can be set as low as 32 VDC, but may shut down on low AC output voltage (due to load). Over-voltage disconnect is 65.5 V. 2) Can be adjusted to 60 Hz 3) MPPT operating range is also constrained by battery voltage - PV VOC should not exceed 8x battery float voltage, e.g. a 50 V battery voltage maximum should have 400 V maximum PV array. – see product manual for further information. 4) Programmable relay which can be set for general alarm, DC under voltage or genset start/stop function. DC rating: 4 A up to 35 VDC and 1 A up to 70 VDC 5) Protection key: a) output short circuit b) overload c) battery voltage too high d) battery voltage too low e) temperature too high f) 230 VAC on inverter output g) Solar earth leakage 6) Connection to a GX device (i.e. Cerbo GX) must be made via the VE.Can interface. The VE.Direct interface is for connection to the GlobalLink S20, and to a computer, using a VE.Direct to USB to cable. 7) The Charger set-point (float and absorption) can be set to max 60 V. The output voltage at the charger terminals can be higher, due to temperature compensation as well as compensation for voltage drop over the battery cables. The maximum output current is reduced on a linear basis from full current at 60 V to 5A at 62 V. The equalization voltage can be set to max 62V, the equalization current percentage can be set to max 6%.		